



OBIS LX/LS Laser Box

Laser Mount with Cooling, Interface and Power Supply

OBIS LX and OBIS LS laser products come with a variety of accessories to support your application needs.

The OBIS Laser Box for OBIS LS and OBIS LX offers all the features from the laser in a convenient CDRH-compliant interface with convection cooling for five lasers.

As with all OBIS LX and OBIS LS lasers, the laser itself offers a stand-alone all-in-one laser solution. OBIS lasers come with a Power Connection, USB Connection, Fan Connection and a SDR-type Connection for laser control I/O. All of these are on the back panel of every OBIS LX/LS laser.

To simplify integration, the OBIS Laser Box connects to the single SDR-type connector for power, signals and communication. The OBIS Laser Box then brings all of these features to the front panel controls and connectors.

The OBIS Laser Box offers stability over temperature with conduction cooling for the laser baseplate and cooling fans to maintain the convection cooling.

Every OBIS Laser Box comes with a separate 12V DC power supply with capacity to drive the five lasers, interface and cooling.

FEATURES

- Integrated five bay mount for OBIS lasers
- Heat sinks and cooling fans
- Modulation inputs for analog and digital for five lasers
- USB and RS-232 interface for additional control from host computer
- Coherent Connection software for PC
- Status indicators for each laser
- External power supply
- Laser safety features such as key switch and interlock

APPLICATIONS

- Laboratories needing CDRH features
- Applications wanting a simple Analog or Digital inputs to control the laser
- Applications wanting thermal management (cooling) for the lasers



SPECIFICATIONS ¹	OBIS LX/LS Laser Box
OBIS Laser Box Laser Box – five bay ¹ Power Supply ²	Part #1228877 Included
Host Computer Remote Control via USB ³	USB 2.0, Mini B
Host Computer Remote Control via RS-232 ³	RS-232, 115.2K, 8N1, DB-9F
Analog Inputs, 5 each	SMB Connector, 0V to 5V, 2000 Ohm input impedance
Digital Inputs ⁴ , 5 each	SMB Connector, 0V to 3V, 50 Ohm input impedance
Interlock	Yes, included with shorting wire
Laser Status Indicators	Yes, Individual LED for each Laser
Warm-up Time (minutes) (from cold start)	<2
Coherent Connection Software for PC	Included on USB drive with user manual
Safety	Key switch and interlock
UTILITY AND ENVIRONMENTAL REQUIREMENTS	
Power Consumption (W) (typical)	5 (without lasers)
Power Consumption (W) (maximum)	140 (with 5 lasers)
Internal Cooling Fan	Yes, 3 each
Power Input to Laser Box, 6 Pin (VDC)	10 to 14 at 10A maximum, Molex P/N 43025-0600 for mating connector
Power Cord (USA)	2.4m (8 ft.)
Operating Condition ⁵ (°C)	10 to 40 for OBIS LX, 10 to 35 for OBIS LS
Non-operating Condition ⁵ (°C)	-10 to 60
Shock Tolerance (g) (6 ms)	20
Operating Voltage (VAC)	90 to 264, 47 to 63 Hz
Dimensions (L x W x H)	
Laser Box	241 x 184 x 88 mm (9.5 x 7.3 x 3.5 in.)
Power Supply	189 x 89.4 x 47.1 mm (7.4 x 3.5 x 1.9 in.)
Weight	
Laser Box	3.9 kg (8.5 lbs.)
Power Supply	0.9 kg (2.0 lbs.)



¹ Lasers sold separately.



² Power supply included. Order item number 1211389 for spare or replacement.

³ Host computer not provided. RS-232 and USB cable not provided.

⁴ Digital Modulation can be driven up to 5 Volts.

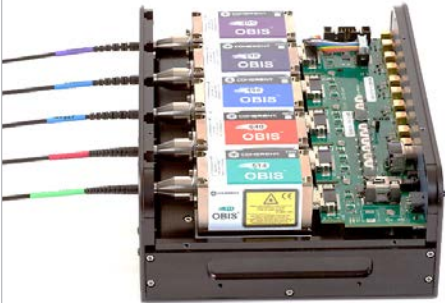
⁵ Non-condensing.

Example of OBIS Laser System	Description
	<p>Figure 1: Laser Box with the lid removed</p>
	<p>Figure 2: Laser Box example as part of a Galaxy beam combiner system. Lasers and Galaxy Beam Combiner sold separately.</p>
	<p>Figure 3: Laser Box example with 5 lasers installed. Lasers sold separately.</p>

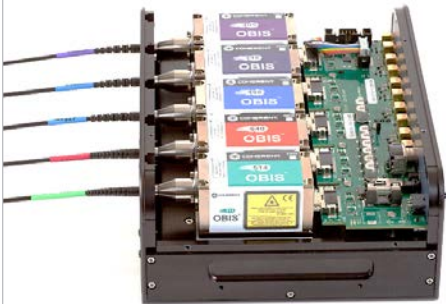
Other OBIS Laser Remotes	Description
 <p>A compact, black rectangular remote control with a silver front panel. It features a power knob on the left, several status LEDs (LASER READY, FAULT, REMOTE CONTROL, CAUTION), and a green interlock connector on the right. The COHERENT logo is visible on the top surface.</p>	<p>OBIS LX/LS Single Laser Remote with full features for control with analog/digital inputs. Includes USB and RS-232 on the Remote.</p>
 <p>A black rectangular remote control with a silver front panel. It features a power knob on the left, six color-coded buttons (375, 405, 488, 532, 640, 685), and a green interlock connector on the right. The COHERENT logo is visible on the top surface.</p>	<p>OBIS LX/LS 6-Laser Remote with CDRH features. Separate power switches and power cables for each laser.</p>
 <p>A larger, black rectangular remote control with a silver front panel and a black carrying handle. It features a power knob on the left, a large touch screen in the center, and several status LEDs and connectors on the right. The COHERENT logo is visible on the top surface.</p>	<p>OBIS LX/LS Scientific Remote with full features for control with analog/digital inputs for up to six lasers. User interface touch screen and connectivity through USB, RS-232 and Ethernet.</p>
 <p>A black rectangular laser box with a silver front panel. It features five laser mounting bays on the left side, each with a fiber optic cable. The front panel has a power knob, status LEDs, and connectors. The COHERENT logo is visible on the top surface.</p>	<p>OBIS LX/LS Laser Box with five laser mounting bays with thermal management, cooling fans, analog/digital inputs, RS-232, USB, key-switch and interlock in one compact package. Lasers sold separately.</p>

MECHANICAL SPECIFICATIONS

OBIS LX/LS Laser Box

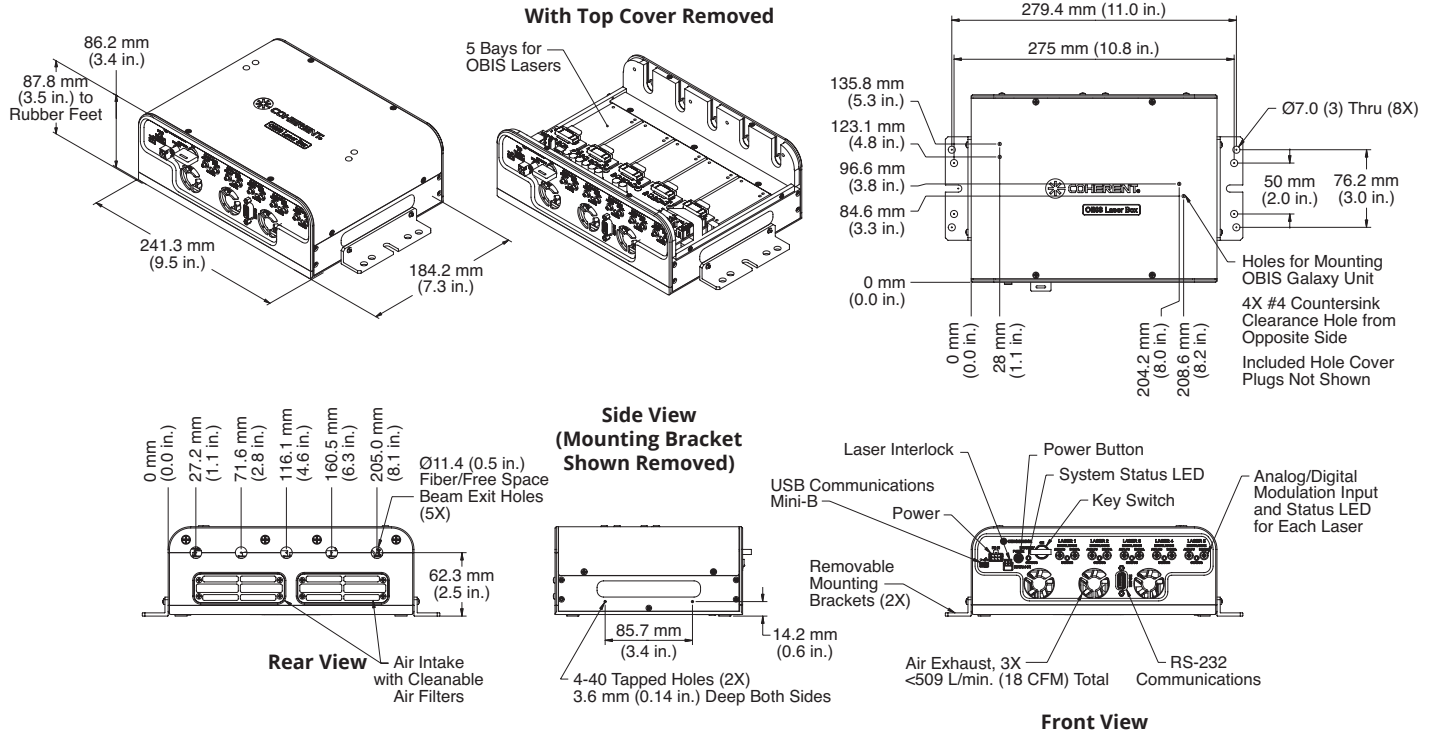

OBIS 6-Laser Remote Power Supply

Part #1211389 included

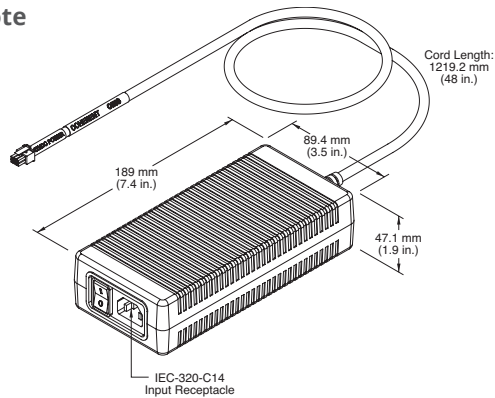

Coherent, Inc.,
 5100 Patrick Henry Drive Santa Clara, CA 95054
 p. (800) 527-3786 | (408) 764-4983
 f. (408) 764-4646

tech.sales@Coherent.com www.Coherent.com

Coherent follows a policy of continuous product improvement. Specifications are subject to change without notice. Coherent's scientific and industrial lasers are certified to comply with the Federal Regulations (21 CFR Subchapter J) as administered by the Center for Devices and Radiological Health on all systems ordered for shipment after August 2, 1976.

Coherent offers a limited warranty for all OBIS LX/LS Laser Boxes. For full details of this warranty coverage, please refer to the Service section at www.Coherent.com or contact your local Sales or Service Representative. Printed in the U.S.A. MC-030-13-0M0317Rev.C Copyright ©2017 Coherent, Inc.