

# DIAMOND C-70 Series

Low Power CO<sub>2</sub> OEM Lasers  
for Marking, Engraving and Cutting Applications

The Coherent C-70 CO<sub>2</sub> laser provides 70 Watts of power with best-in-class reliability and package size, making it well suited for demanding high speed and large area laser marking and engraving systems, as well as many cutting applications. This production-ready, easy-to-integrate laser system enables high performance with low maintenance and operating costs. The C-70 is ideal for laser processing of many materials, including paper, plastics, wood, rubber, leather, cloth and more.

The C-70 is part of the Coherent C-series family of products which offer a full range of power levels – from 20W to 70W. Based on a sealed waveguide and integrated RF power supply design, the C-70 boasts outstanding production-proven reliability, while delivering excellent beam quality, power stability and pulse control in a compact, flexible and integrated package. The modular platform design provides cost-effective optimization of operating wavelength (from 9.3 to 10.6  $\mu\text{m}$ ) and cooling configuration (air/liquid), enabling rapid adaptability to changing applications and market needs.

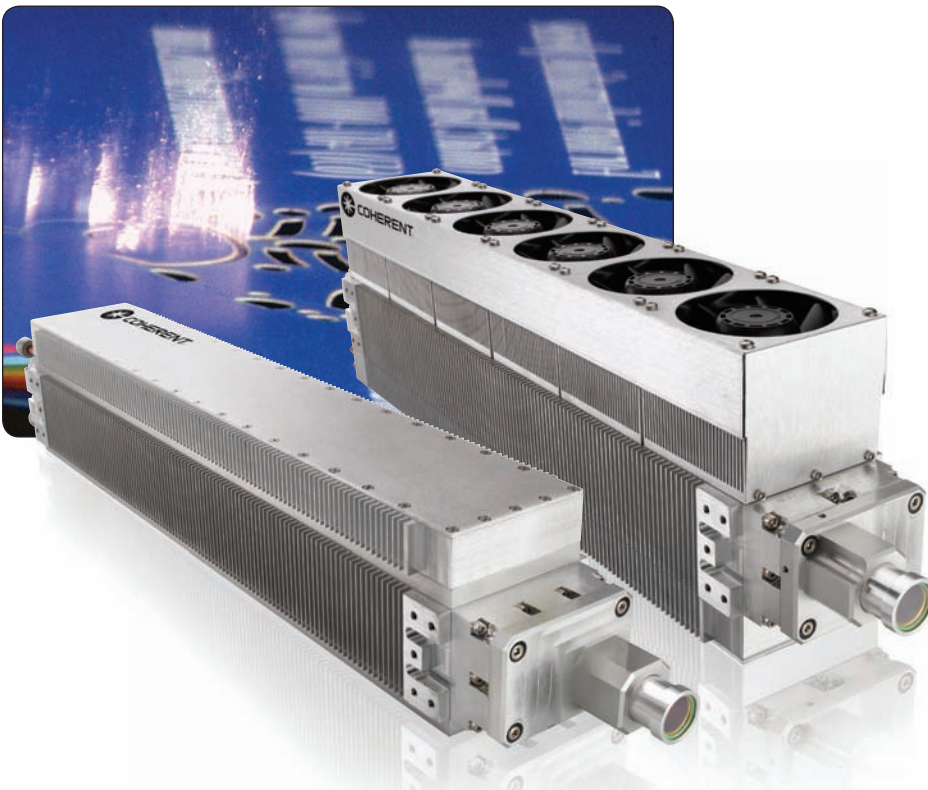

**Superior Reliability & Performance**

## **DIAMOND C-70 Series Features:**

- Superior beam quality, power stability and reliability
- Industry leading compact size with integrated RF power supply
- Versatile power range and pulse frequency control (CW or PWM)
- High speed laser processing on a wide range of materials
- Available in multiple wavelengths (9.3  $\mu\text{m}$  to 10.6  $\mu\text{m}$ ) and cooling configurations (air or liquid)

## **DIAMOND C-70 Series Applications:**

- Marking
- Engraving
- Cutting
- Medical and Dental
- Food, Beverage and Pharmaceutical Packaging
- Microelectronics and Consumer Electronics
- Automotive and Electronic Components

# DIAMOND C-70 Series

Low Power CO<sub>2</sub> OEM Lasers for Marking, Engraving and Cutting Applications

## System Specifications<sup>1</sup>

	C-70A	C-70L
Wavelength (µm)	10.55 to 10.63	
Optical Output Power <sup>1</sup> (W)	70	
Power Stability <sup>2</sup> (%)	±5	
Mode Quality (M <sup>2</sup> )	<1.3	
Beam Size (mm)	3.6 ±0.5 at output aperture	
Beam Divergence (mrad, full angle)	<5	
Polarization	>100 to 1 (fixed linear, parallel to width dimension)	
Operating Frequency and Duty Cycle	0 to 25 kHz, 0 to 100% DC	

## Configuration and Facility Requirements

Weight	10.2 kg (22.5 lbs.)	9.7 kg (21.5 lbs.)
Dimensions (L x W x H)	604.9 x 92.5 x 154.5 mm (23.8 x 3.64 x 6.08 in.)	647.5 x 92.5 x 104.1 mm (25.5 x 3.64 x 4.1 in.)
Input Power <sup>3</sup>	48 VDC, 20A	
Cooling	Air	Liquid
Heat Dissipation (W)	<1200	
Maximum Case Temperature	<60°C (140°F)	
Operating Environment		
Temperature	5 to 40°C (41 to 113°F)	
Altitude	<2000 m (6500 ft.)	
Humidity	Non-condensing	
Shipping/Storage Environment	-10 to 60°C (14 to 140°F), non-condensing	
Coolant	Distilled water with 25 to 35% Dow Frost*	
Coolant Flow Rate	>3.8 lpm (1.0 gpm)	
Maximum Coolant Pressure	7 kg/cm <sup>2</sup> (100 psig)	
Max. Pressure Differential (at 1.0 gpm)	3.2 bar (46 psig)	
Coolant Temperature	15 to 30°C (59 to 86°F)	

<sup>1</sup> Power measured at 25°C and derated by 1%/C for higher laser head temperatures.

<sup>2</sup> Power stability based on  $\pm(P_{max} - P_{min}) / (2 * P_{max})$  average power measurement at constant duty cycle after 10-minute warm-up at operating condition.

<sup>3</sup> The overall height dimension is taller for the Dual Chillplate version of this item.

<sup>4</sup> Optional fans add 1A.

\* Dow Frost is a trademark of the Dow Chemical Company.

## Mechanical Specifications

### C-70L Laser Head

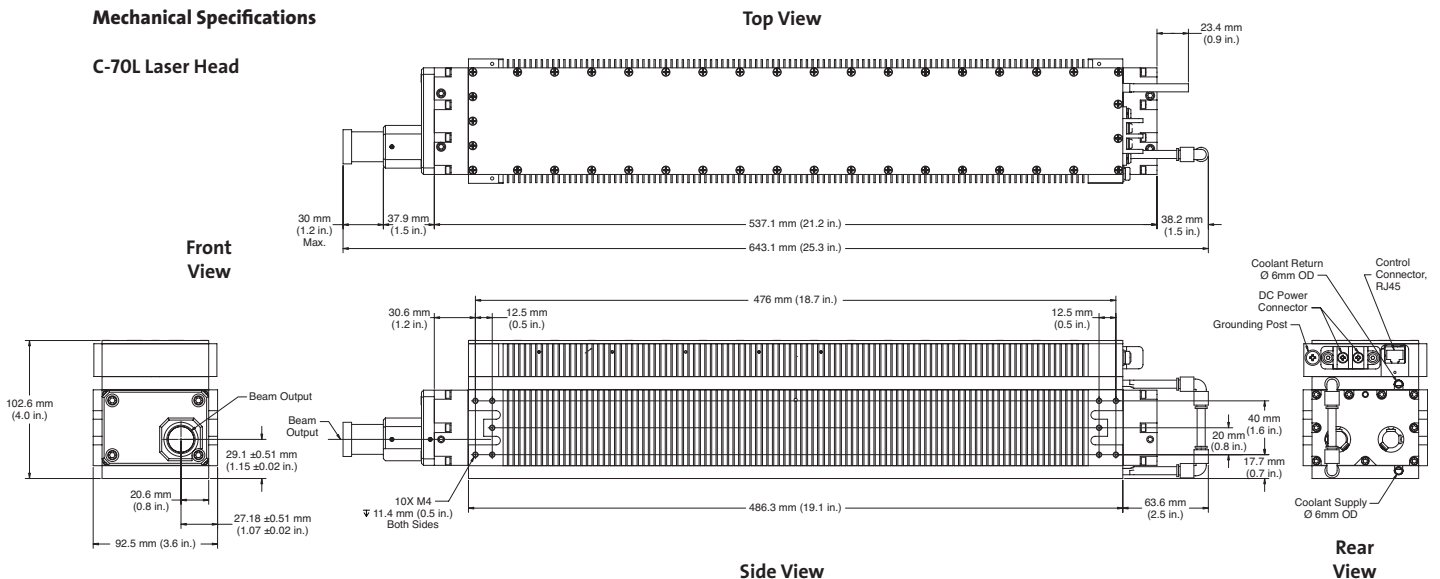

# DIAMOND C-70 Series

Low Power CO<sub>2</sub> OEM Lasers for Marking, Engraving and Cutting Applications

## Mechanical Specifications

### C-70A Laser Head

Top View

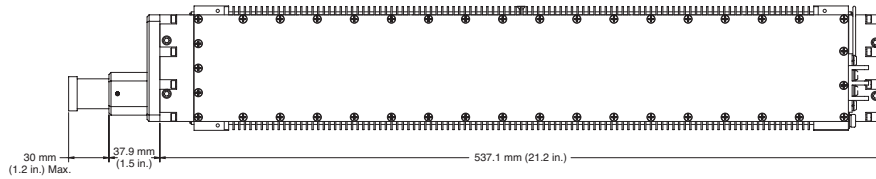

Front View

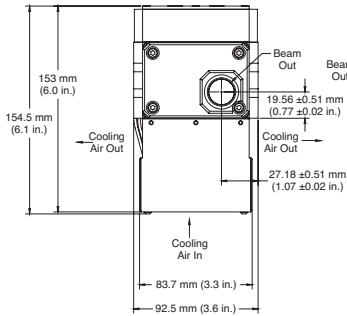

Rear View

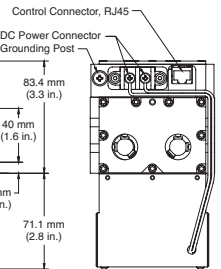

Side View

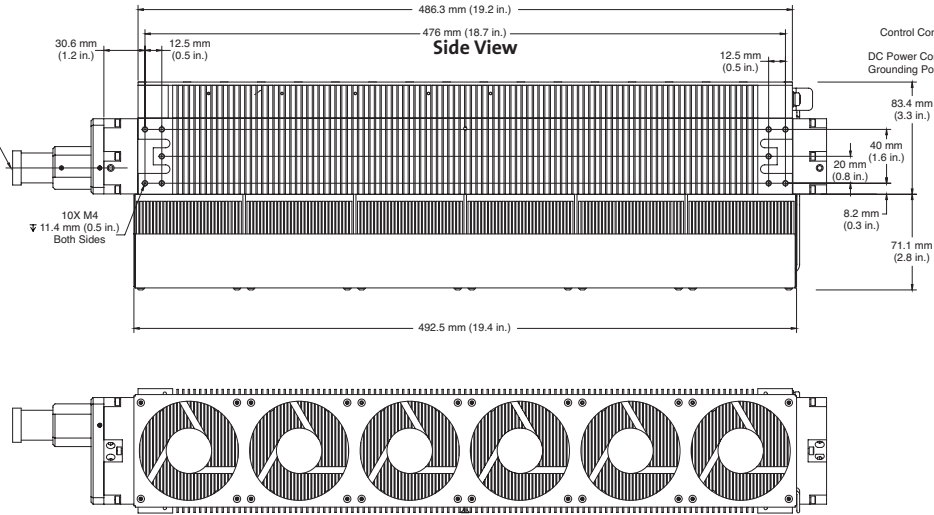

Bottom View



[www.Coherent.com](http://www.Coherent.com)

#### Coherent, Inc.,

5100 Patrick Henry Drive  
 Santa Clara, CA 95054  
 phone (800) 527-3786  
 (408) 764-4983  
 fax (408) 764-4646  
 e-mail [tech.sales@Coherent.com](mailto:tech.sales@Coherent.com)

Benelux +31 (30) 280 6060  
 China +86 (10) 8215 3600  
 France +33 (0)1 8038 1000  
 Germany/Austria/  
 Switzerland +49 (6071) 968 333  
 Italy +39 (02) 31 03 951  
 Japan +81 (3) 5635 8700  
 Korea +82 (2) 460 7900  
 Taiwan +886 (3) 505 2900  
 UK/Ireland +44 (1353) 658 833

Coherent, Inc. guarantees that the output power of the C-70 Series will exceed the rated power for a period of 24 months, independent of the actual operating time. Coherent, Inc. also warrants to the original purchaser for a period of 24 months from the date of delivery that the C-70 Series is free from defects in material and workmanship. The warranty does not apply to any unit damaged by accident, abuse or operation in a manner inconsistent with the procedures and specifications outlined in the manual supplied with the laser.

The C-70 Series is a laser component that does not include all safety features as required by the FDA and the Center for Devices and Radiological Health (CDRH). It is sold solely to qualified manufacturers who in their end product will supply all interlocks and indicators, and will comply fully with CDRH regulations and/or local regulatory agencies.

